

Combi Round Slimline Worktop Basin 1054 LH

SIZE(mm): W 1054 x D 340 X H 160

CODE: MLCORDSLI0LHBA

TAP HOLE(S): Pre-Drilled Underneath for an offset taphole only

MATERIAL: Resin

ORIENTATION: Left Hand

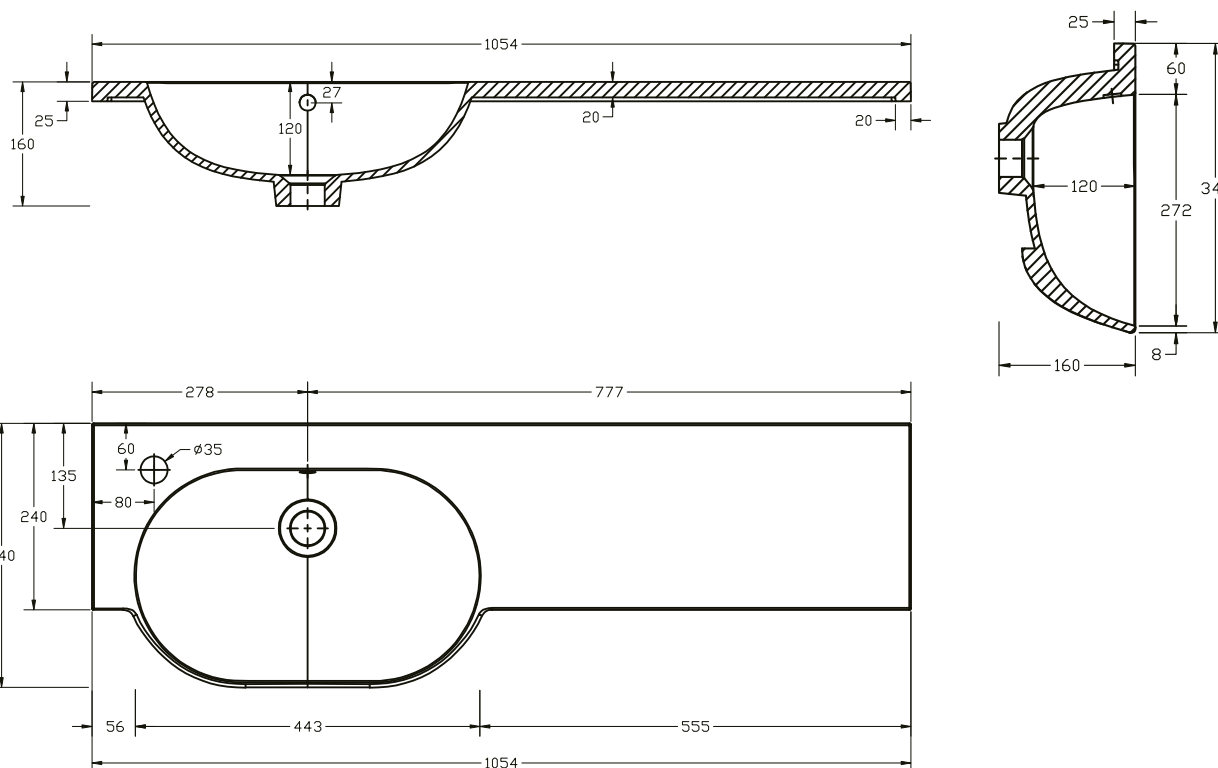

Please Note:

1054mm Combi Round Worktop Basin is to be used exclusively with 500mm Fitted Furniture Basin Units, leaving adequate space for 500mm of Furniture (Storage or WC) and two end panels.

The information contained on this page was correct at date of issue. Fitting dimensions are provided as a guide only. Some variation may occur due to manufacturing tolerances. We pursue a policy of continuing improvement in design and performance of our products and so reserve the right to change specifications without prior notice.