

Patton Standard Semi Recessed 550 Basin

SIZE(mm): W 550 x D 450 X H 160

CODE: MLPA55SRBA

TAP HOLE(S): One

MATERIAL: Resin

TYPE: Standard

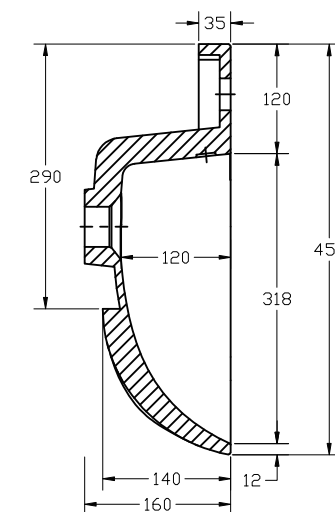
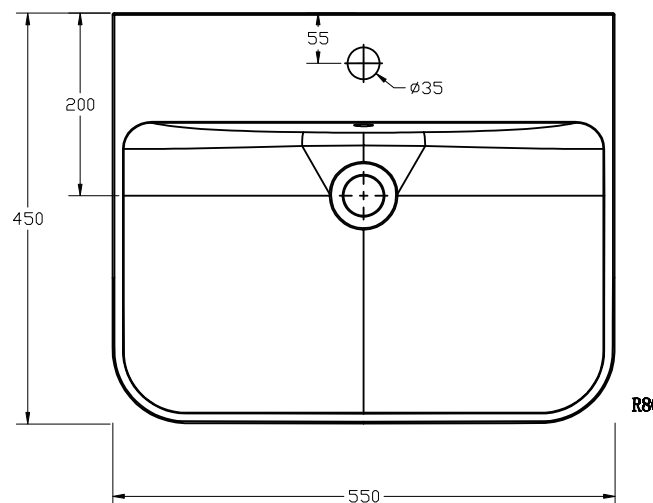
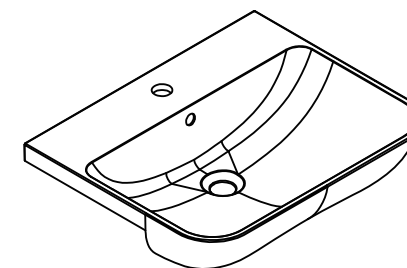
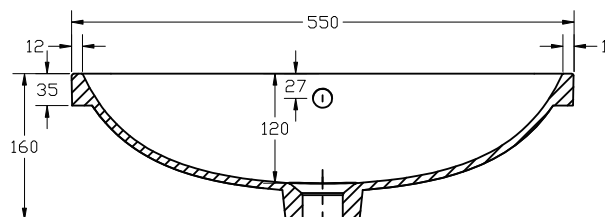

The information contained on this page was correct at date of issue. Fitting dimensions are provided as a guide only. Some variation may occur due to manufacturing tolerances. We pursue a policy of continuing improvement in design and performance of our products and so reserve the right to change specifications without prior notice.