

Thermostatic Mixer Valve & Diverter - 2 Outlet

CODE	MLSH2OTMVD
CONSTRUCTION	Brass Body (CuZn38b18)
FINISHES	Brass
PRODUCT TYPE	Contemporary
WATER PRESSURE	Min. 0.5 bar, Max. 6.0 bar
PLUMBING SYSTEMS	Suitable for all plumbing systems, preferably balanced. Min. supply pressure differential requirement is 5:1
STANDARDS	Complies with BSEN 1111
CARTRIDGE	Vernet Thermostatic Cartridge
DIVERTER	Citec Diverter
ADDITIONAL INFO	<ol style="list-style-type: none"> 1. Temperature: Pre-set 38°C, with push button override to 48°C 2. Automatic shut off in the event of hot or cold water supply failure

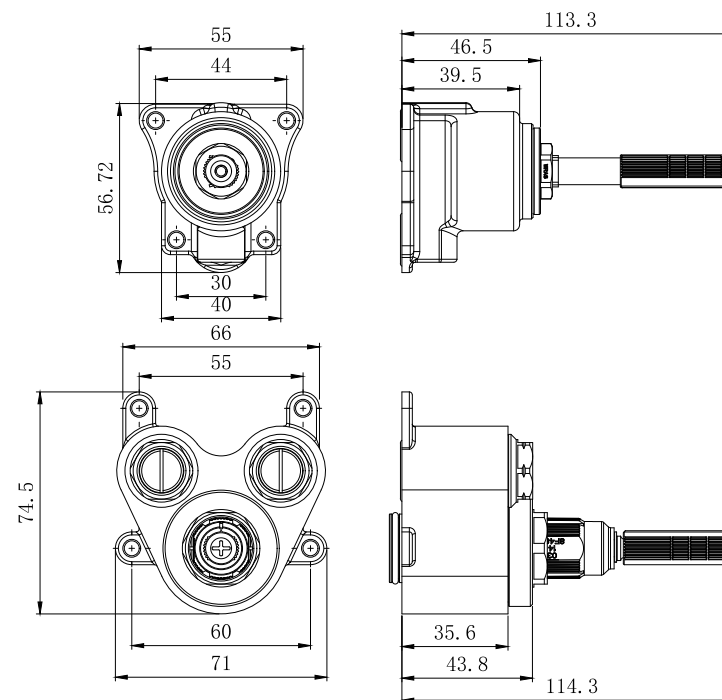

Flow Rates (Litres per minute)

SYSTEM PRESSURE	0.1 Bar	0.2 Bar	0.3 Bar	0.5 Bar	1.0 Bar	1.5 Bar	2.0 Bar	3.0 Bar	4.0 Bar	5.0 Bar
	4.5	5.9	7.0	8.9	12.4	-	17.3	21.4	24.8	27.8

The information contained on this page was correct at date of issue. Fitting dimensions are provided as a guide only. Some variation may occur due to manufacturing tolerances. We pursue a policy of continuing improvement in design and performance of our products and so reserve the right to change specifications without prior notice.